



# **Energy palm AIR TO WATER HEAT PUMP**

## **Installation and Operation Manual**

**For**

**H series: Only Heating series**

**AC series: Heating & Cooling series**

**HC series: Multifunctional Heating Cooling & Hot water**

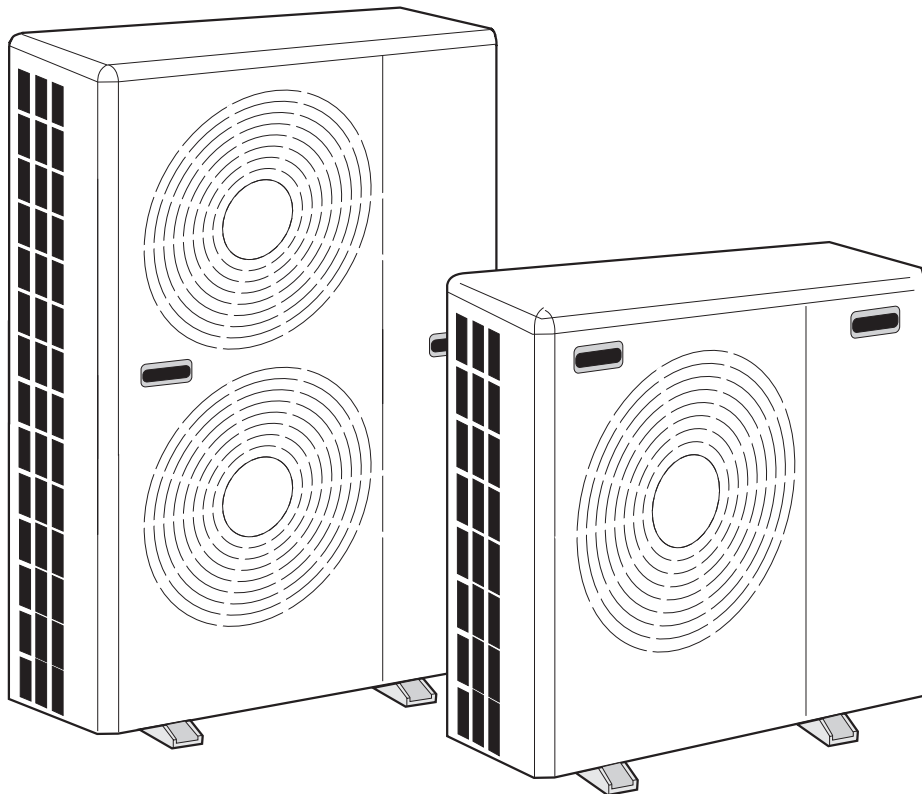

# Content

<b>1 Safety Precautions</b> .....	1
1.1 General .....	1
1.2 Transport and storage .....	1
<b>2 Components</b> .....	2
<b>3 Wired controller</b> .....	4
3.1 Display and button .....	4
3.2 Operating the unit .....	5
3.3 Week and clock setting .....	7
3.4 Timer setting .....	8
3.5 Parameter inquiry and setting .....	10
3.6 Black box historical data function .....	12
<b>4 Error code</b> .....	14
<b>5 Installation</b> .....	15
5.1 Installation information .....	15
5.2 Installation method .....	16
5.3 Dimensions .....	18
5.4 Installation position .....	19
<b>6 Electric connection</b> .....	20
6.1 General .....	20
6.2 Cable connection .....	21
6.3 Wiring diagram .....	24
<b>7 Test run</b> .....	26
7.1 Preparation .....	26
7.2 Water replenishing .....	26
<b>8 Technical data</b> .....	27
Technical data table .....	27
<b>9 Temperature sensor data</b> .....	28
<b>10 Heat pump test run</b> .....	30

# 1. Safety Precautions

## Note!

*It is required to read the Safety precautions in detail before operation. The precautions listed below are all-important for safety, please obey without fail.*

## 1.1 General

- ❗ Make sure that the fixed ground wire in the building is securely connected to earth.
- ❗ Wiring tasks should be carried out by qualified electricians only, in addition, they should check the safety conditions of power utilization, for example, check if the line capacity is adequate, and check if the power cable is damaged.
- ❗ Users must not install, repair or relocate the unit.  
Improper treatment might lead to the accidents e.g. personal injury caused by fire, electrical shock or unit's falling-off, and water leakage in the machine. Please contact professional repair and service department of local dealer.
- ❗ The unit shall not be installed at a spot with potential hazard of leakage of inflammable gas.  
In case the leaked gas is congregated around the machine, there might be the risk of explosion.
- ❗ Make sure that the foundation of installation is stable.  
If the foundation is unstable, the outdoor unit may drop and cause a casualty accident. so this must be validated carefully.
- ❗ Make sure that the electric leakage protection switch is fixed.  
If no electric leakage protection switch is fitted at the beginning of the electric supply, it maybe cause electric shocks or fires.
- ❗ If any abnormality occurs in the unit (such as burned taste inside the unit), cut off the power supply immediately, and contact professional repair and service department of local dealer.
- ❗ Please observe the follow items when cleaning the unit..  
Before cleaning, shut off the electric supply of the unit firstly to avoid injuries caused by fan in operation.  
Do not rinse the unit by water because the rinsed unit may cause electric shock.
- ❗ Make sure to shut off the electric supply before maintain the unit.
- ❗ Please do not insert fingers or sticks into air outlet or air inlet.

## 1.2 Transport and storage

- ❗ The machine must be transported and stored vertically.

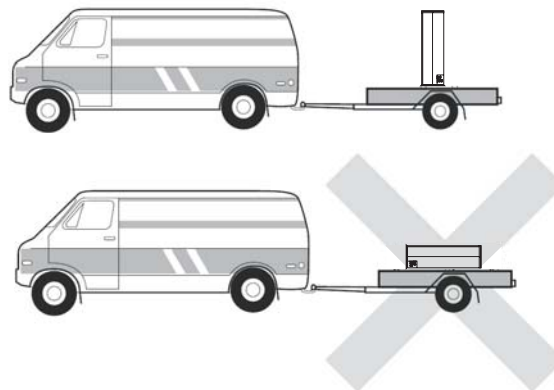

Model No Illustration:

**AHP-MXXAC-410**

- Refrigerant type. 410:R410a; 22:R22
- Unit type. H:Heating only; C:Cooling only;  
AC:Heating&Cooling; HC:Multifunctional(Heating,Cooling&DHW)
- Capacity(unit:kw)
- M:230V/60HZ; N:115V/60HZ; Omitted:230V/50HZ
- With inner circulation pump

## 2 Components

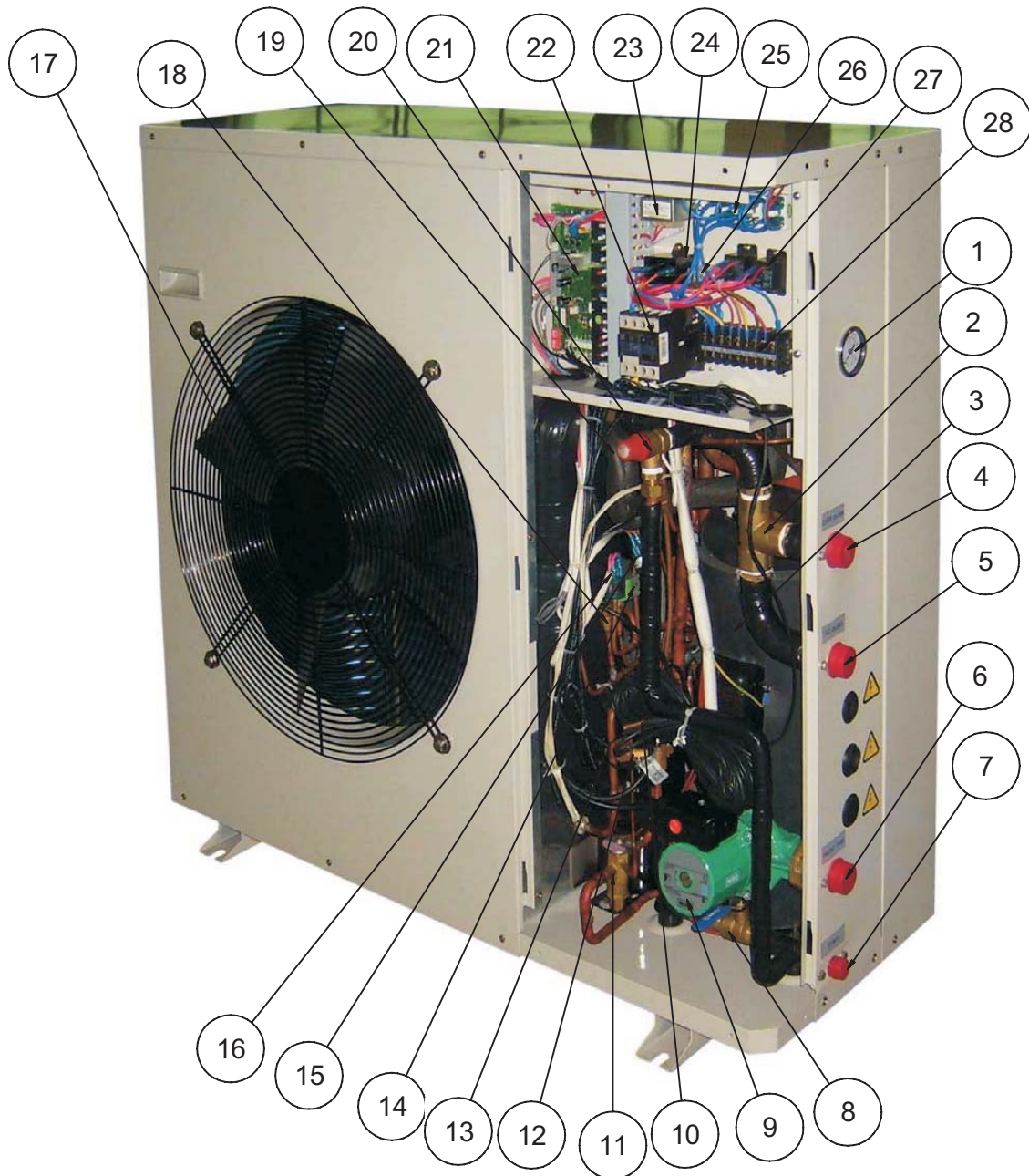

Parts List					
NO.	Description	Quantity	NO.	Description	Quantity
1	Water pressure gauge	1	16	Low pressure switch	1
2	Electrical three-way valve	1	17	Fan	1
3	Compressor	1	18	R410A Needle valve	2
4	D.H.W outlet	1	19	Gas-liquid separator	1
5	A.C water outlet	1	20	Safety valve	1
6	Water return	1	21	PCB	1
7	Drain	1	22	AC contactor	1
8	Ball valve switch	1	23	Transformer	1
9	Circulation water pump(optional)	1	24	Fan motor capacitor	1
10	Temperature thermistor	7	25	Wire terminals	3
11	Thermal expansion valve	1	26	AC relay-1	1
12	Water differential pressure switch	1	27	AC relay-2	2
13	High-pressure reservoir	1	28	Power Terminal Block	1
14	Bypass solenoid valve	1			
15	High pressure switch	2			

## 3 Wired controller

### 3.1 Display and Button

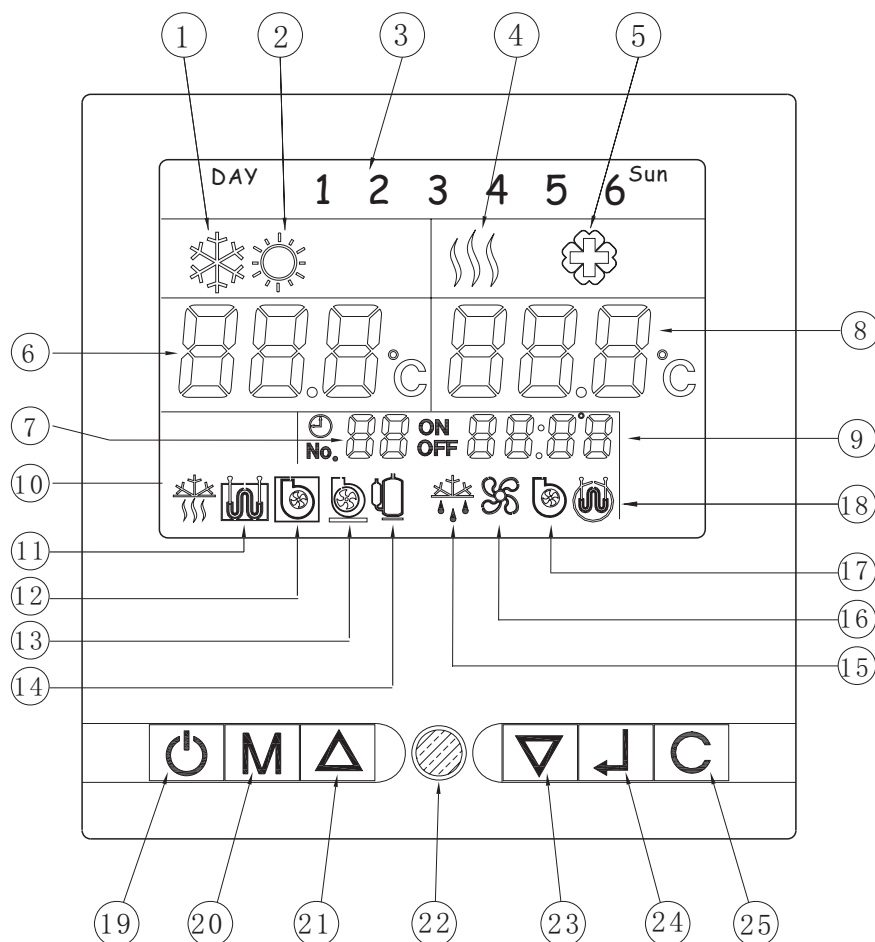

#### Display

- 1.Cooling operation mode
- 2.Heating operation mode
- 3.Day display
- 4.DHW operation mode
- 5.Antibacterial(legionella)function
- 6.A/C returned water temp  
or Outdoor ambient temp in only Heating series
- 7.Timer number
- 8.DHW temperature  
or Outdoor ambient air temp in heating/cooling series
- 9.Clock
- 10.Anti-freezing running
- 11.A/C heater
- 12.Main water pump C4
- 13.A/C water pump C6
- 14.Compressor

- 15.Defrost running
- 16.Fan motor
- 17.DHW water pump C5
- 18.DHW heater

#### Button

- 19.ON/OFF button
- 20.Mode selector key
- 21.Up key
- 22.LED Indicator
- 23.Down key
- 24.Confirm key
- 25.Clear key

Notes:1.When the unit is freeze-proofing mode or defrost mode, and will appear or flicker.

2. If are solid,it means that the component is working;if they are hollow ,it means that the compenent is un-working.

3. DHW:Domestic hot water;A/C:Air conditioning.

## 3 Wired controller

### 3.2 Operating the unit

#### 3.2-1 OPERATION MODE SHIFT (OPERATING STEPS):

A, in the On / Standby cases, press the M key, air conditioning cooling icon appears and flashes; press M key every time to shift from air-conditioning cooling + domestic hot water mode → air conditioning heating mode → air conditioning heating + domestic hot water mode → domestic hot water mode → back to air conditioning cooling mode again. When select a certain mode, press ] key to confirm, the icon become solid and the heat pump will perform the selected mode. .

B, When select air-conditioning cooling or heating plus domestic hot water, DHW will be priority.

C, When select DHW mode, only hot water operation, no air conditioning running.

D, Health and sterilization is an independent automatic operation mode, if necessary, modify the parameters individually.

#### 3.2-2 modify the setting parameters (steps):

A, when the selected mode is running, the unit will run in accordance with the factory set default values, or the last modification of the temperature.

B, the modification method of set the temperature value

In the On / Standby cases, press M and C keys at the same time 3 seconds, the current operation mode flashes; by pressing the M key, you can switch the sequence in the following order: Cooling / heating / hot water; by pressing the ▲ or ▼ key to change set up fixed value, press ] button to confirm and exit or exit amendment automatically after 15 seconds or press the C key to exit the amendment.

C, the detailed settings in the table below:

Item	Mode	Setting Range	Default	Button operation to modify the parameter
1	A/C Cooling	10°C ~ 25°C	12°C	M+C → M → ▲ or ▼ → ] → C
2	A/C Heating	10°C ~ 55°C (AU)	40°C	M+C → M → ▲ or ▼ → ] → C
3	DHW	10°C ~ 60°C (AU)	50°C	M+C → M → ▲ or ▼ → ] → C
4	Antibacterial	60°C ~ 70°C	65°C	M+C → M → ▲ or ▼ → ] → C

The above AC Heating temp is returned water temp, the actual outlet hot water temp is 5 °C higher. "AU" means automatic temp operation according to factory inner setting.

#### 3.2-3 Health and sterilization time setting (steps):

In the open / standby case, press M and C keys simultaneously for 3 seconds, press M button to make Health sterilization icon (No. 4) appear and then press ▲ or ▼ key to set sterilization temperature value, press ] button to confirm, the number of days appears and flashes, showing the original default settings or 7 (means 7 days), press ▲ or ▼ key to increase or decrease in the number of days scheduled intervals, a minimum of 7 days, a maximum of no more than 99 days, then press ] button to confirm the selection. "ON" characters appear, "hours" appears and flashes, showing the original settings or the default value (default 01: 1:00 a.m. start), by pressing ▲ or ▼ key to change (0-23) and press ] button to confirm, that is, to run the new start time. "ON" characters disappear, "OFF" characters appear, "minutes" appears and flashes, showing the original set or the default value (default 10), by pressing ▲ or ▼ key to change (minimum 10, maximum of no more than 99), and then press ] button to confirm, after setting completion, exit automatically; or automatically exit after 15 seconds.

#### 3.2-4 ] key function description

A, to set any parameters that must press ] button to confirm to be valid, otherwise invalid.

B, in the parameter setting process, if more than 15 seconds there is no button operation, exit parameter settings automatically, we have to pressed ] button to confirm the setting effective and if not pressed ] button, the setting is invalid.

#### 3.2-5 C key function description

Click the C key to cancel current setting not confirmed by pressing ] button and exit setting.

#### 3.2-6 the current time adjustments (steps)

A, press M key 6 seconds, then release, week icon (for example, "4"), flashes. Press ▲ or ▼ selecting between the 1-SUN and then ] key to confirm. As shown below:

### 3 Wired controller

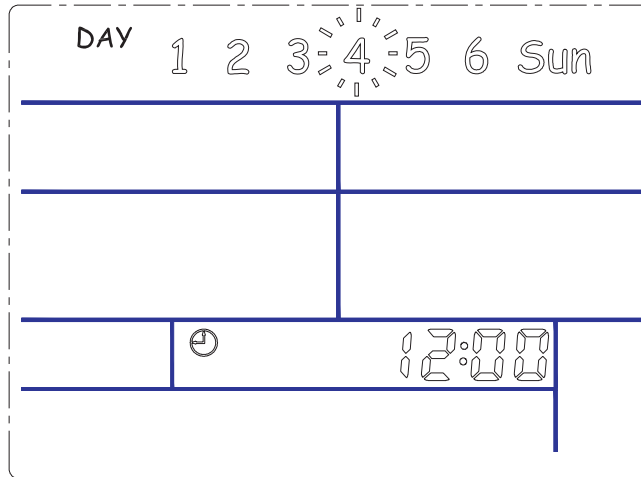

B, the clock icon appears, number of hours flashing, press ▲ or ▼ key to select number between 0 ~ 23, and then ] key to confirm.

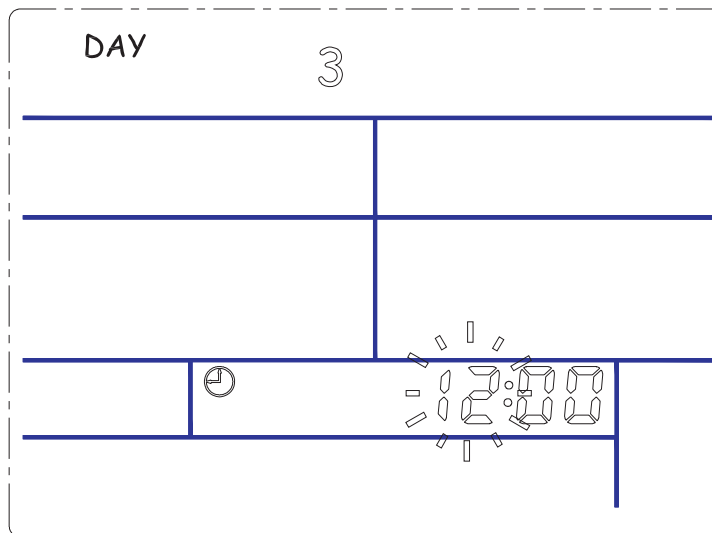

C, at this time the number of minutes flashing, press ▲ or ▼ key to select number between 0 ~ 59, and then press ] button to confirm and exit setting automatically after 15 seconds, or press C key to exit setting.

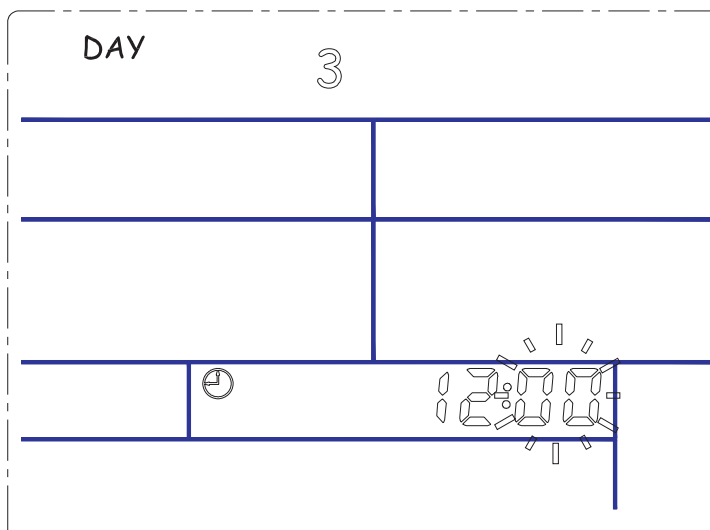

# 3 Wired controller

## 3.3 Week and Clock Setting

Press and hold **M** key for 3 seconds until the week digits on the screen start flashing.

Press **▲** or **▼** key to select the day, press **↓** key to confirm, the number of hour appears and flickers.

press **▲** or **▼** key to adjust hour, press **↓** key to confirm, then the number of minute appears and flickers.

press **▲** and **▼** key to adjust minute , press **↓** to confirm and exit setup interface.

### Weekly timer function

There is a timer on the control system that can be used to program the time that the unit switches on and off. Timing is set to a cycle every week, Mon-Sun each day can be set three different time to turn on, and three different time to turn off, there is an option to select the time set for just one week effective and weekly repeat circulation effective.

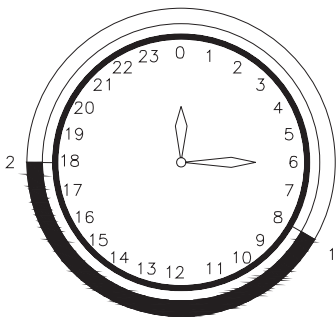

Timing 1 set on/off each day  
Need to set 2 time points

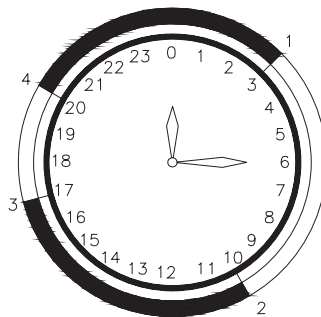

Timing 2 sets on/off each day  
Need to set 4 time points

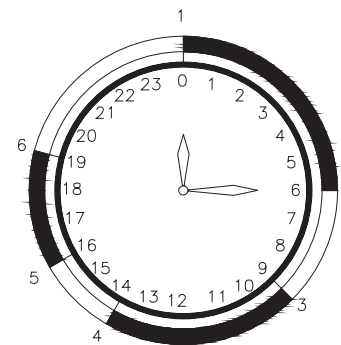

Timing 3 sets on/off each day  
Need to set 6 time points

### Single week effective and repeated effective

Press and hold **M** and **▲** simultaneously for 3 seconds ,the screen appears and flashes “S” or “C” , press **▼** key to select “S” or “C” , press **↓** key to confirm. Select “S” is single week effective, choice “C” is always effective, single week effective and circulation effective timing set in the same way.

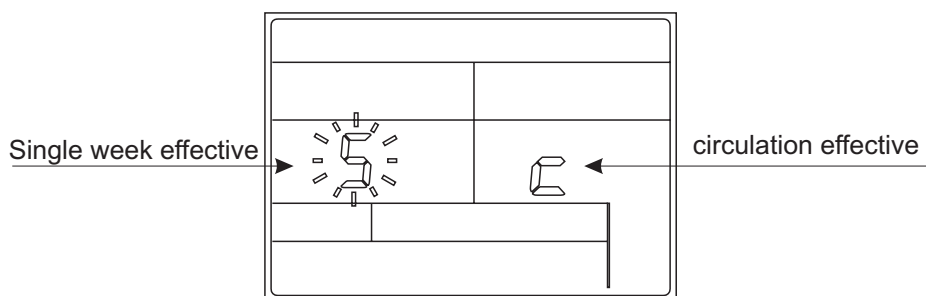



# 3 Wired controller

## 3.4 Timer setting

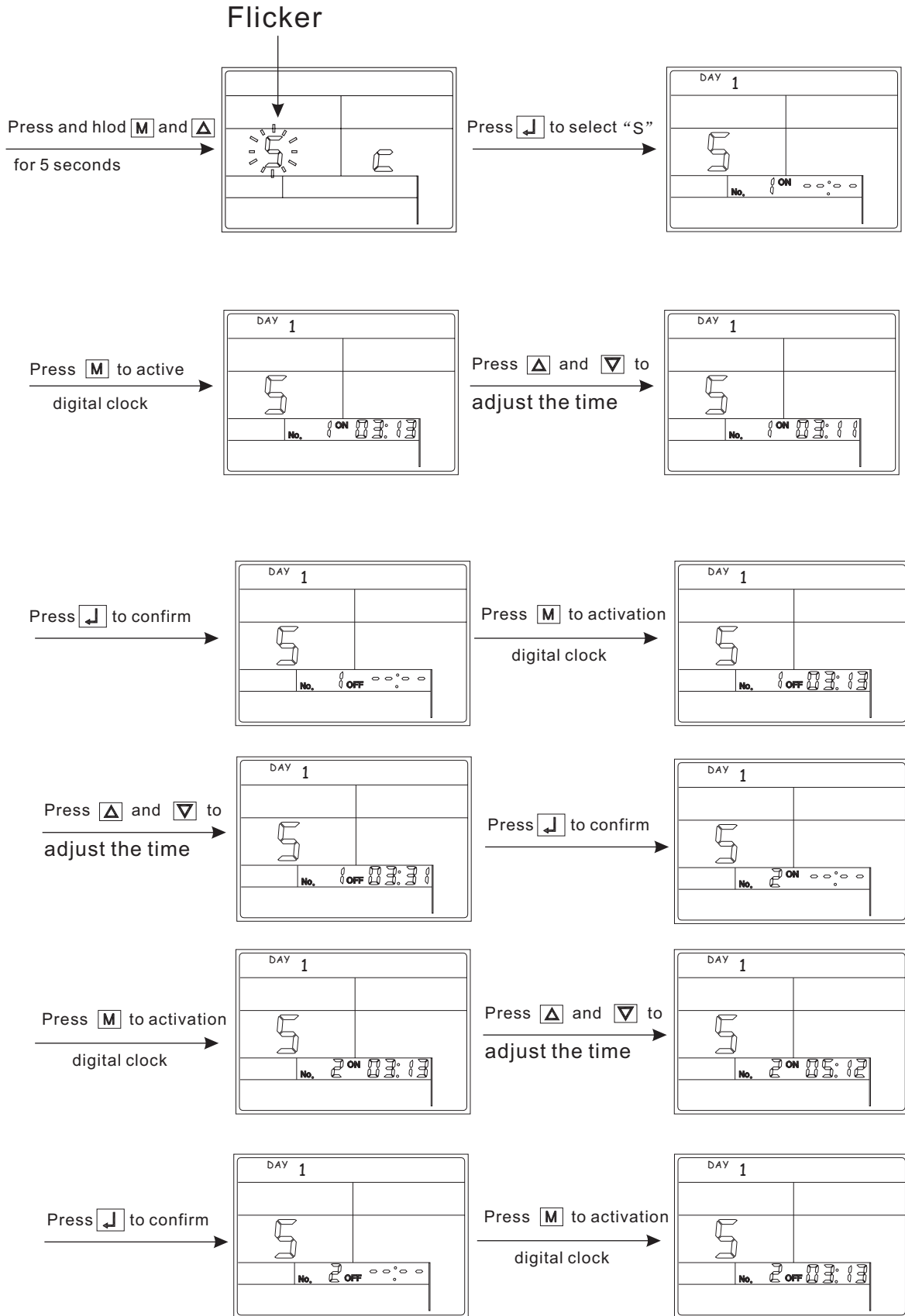

## 3 Wired controller

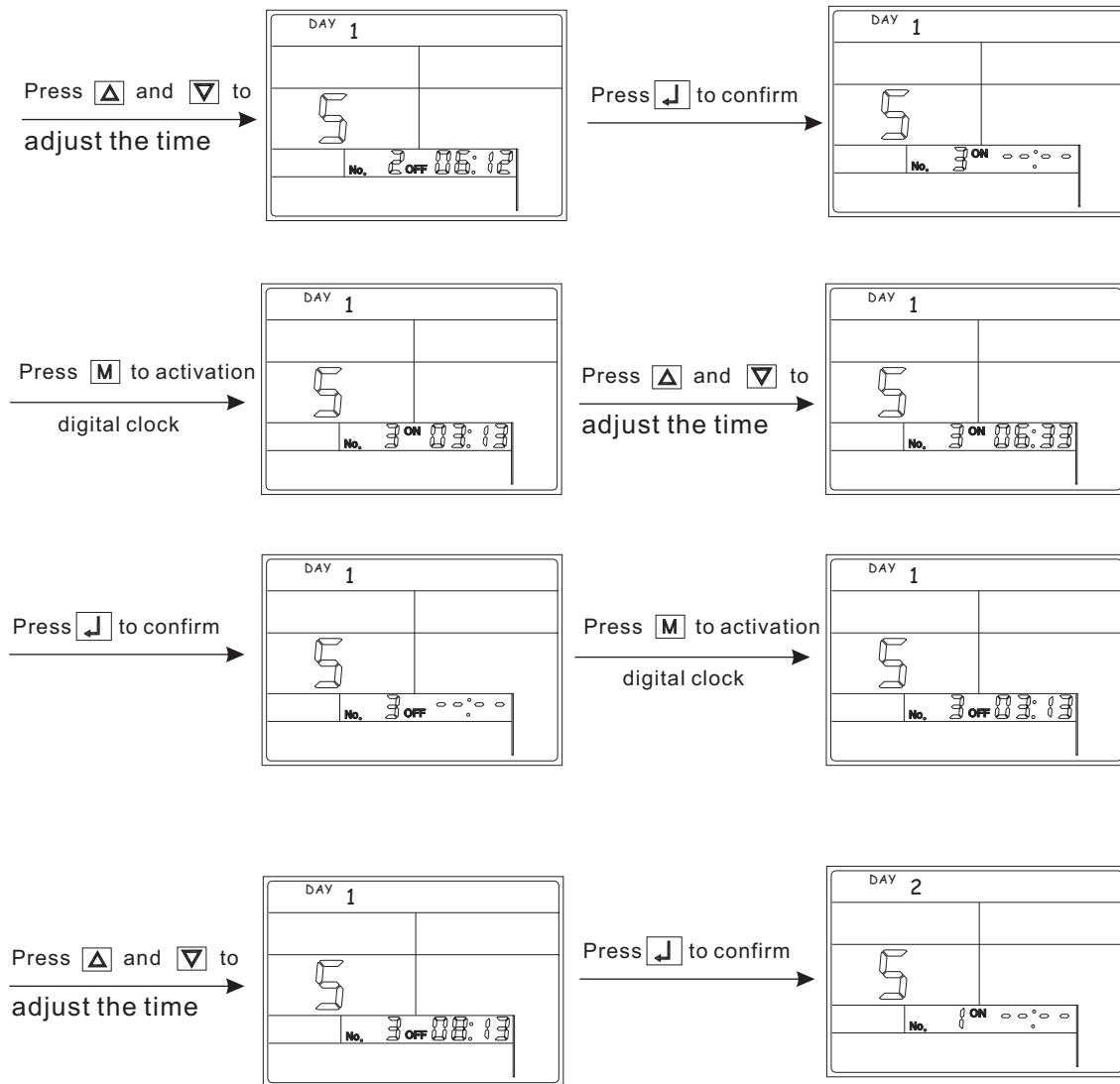

After monday's timer setting is finished, it will be automatically switched to Tuesday's timer setting .until sunday's timer setting is finished,then return to normal display interface.



In the process of setting the timer,if one of the timing time does not need to set,press **[M]** key,the digits of clock change to “--:--”,press the **[↓]** key to confirm.

If a day does not need to change the timing settings, press the **[C]** key to skip to the next day timer settings.

### Clear timer settings

At the same time press **[M]** and **[▲]** for 3 seconds enter into the timer setting interface, and then press the **[▲]** and **[C]** simultaneously for 3 seconds, all the timer settings to be canceled.

## 4 Error Code

Shortly press , you can enter into the error code checking state. Then press , key again, you can check each error code. The error code meaning was given on the function book.

Display "Err Ex" or "Err Px". For example : Err E2, Err P5.

Item	Error Meaning	Error Code	Remark
1	Compressor air discharge temp sensor error	P2	
2	Outdoor coil temp sensor error	P1	
3	Outdoor ambient temp sensor error	P7	
4	Air conditioning returned water temp sensor error	P3	
5	Air conditioning Outlet water temp sensor error	E1	
6	DHW tank water temp sensor error	E9	
7	Solar tank water temp sensor error	Pb	
8	High pressure protection	E4	
9	Low pressure protection	P9	
10	Outdoor water flow error	P8	
11	Indoor water flow error	Pd	
12	Miss phase or wrong phase	PA	
13	Indoor freezing protection	Pb	
14	Compressor air discharge temp too high protection	E3	

## 5 Installation

### 5.1 Installation information

1. Users need to install DHW water tank with coil heat exchanger built inside if this heat pump is used for DHW together with air conditioning function.
2. Water pump can be build inside of outside according to requirement.
3. Even with builtin water pump, user need to check to ensure the minimum water flow volume shown below, If necessary, install external water pumps for DHW circulation or for air conditioning circulation, especially for under floor heating system or several floors application.

#### DHW tank

DHW tank is too small then it may lead to rapid decline in water temperature during use, DHW tanks to use recommended configuration as follows:

Recommended water tank volume and minimum water flow volume:

Model	8KW	11KW	14-15KW	17-18KW	23KW
DHW tank	≥100L	≥100L	≥150L	≥200L	≥300L
Minimum water flow volume (Liter/Hour)	1300L/h	1800L/h	2400L/h	3000L/h	3500L/h

#### Pipe connection

##### **Note!**

**To keep the heat pump from freezing, please do not shut off the power supply of the heat pump in winter. If the electricity is out of supply in winter, please drain out the water in the heat pump or you can use brine (mixed 20% to 40% glycol) to replace pure water in case of electric cut off accident during winter.**

Pipe installation must be carried out in accordance with current standard and directives.

All outdoor pipes must be thermally insulated with at least 19 mm thick pipe insulation.

The pipe must be clean and has no dust and fragments inside.

Piping connections of domestic hot water and air-conditioning must install filters.

Piping connections must ensure that it is no leakage.

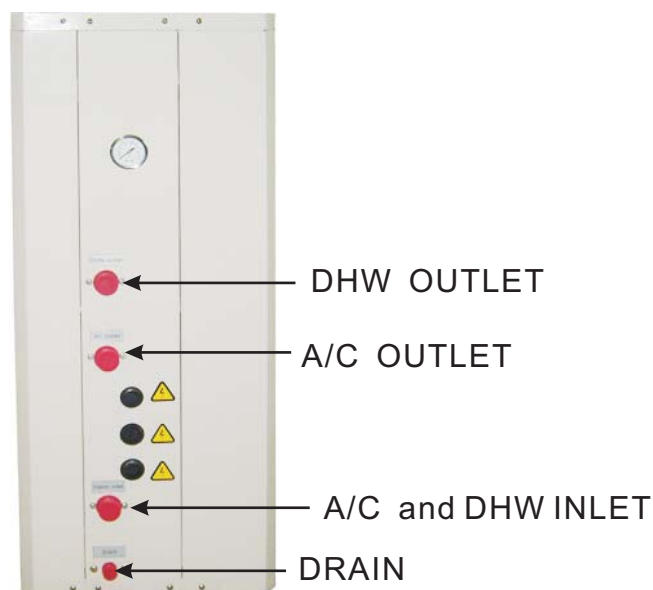

Note: DHW: Domestic hot water; A/C: Air conditioning

# 5 Installation

## 5.2 Installation method

### Method 1

#### Only DHW

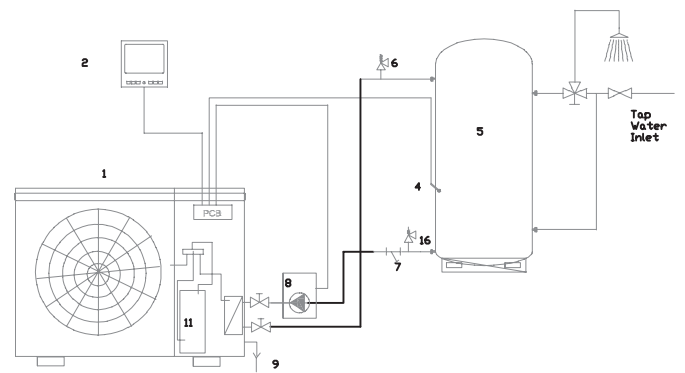
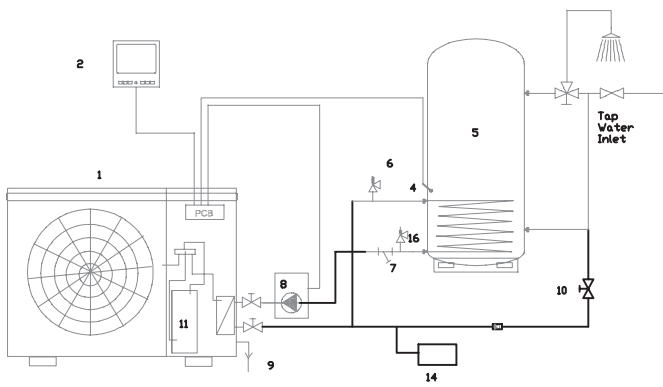

- |                     |   |
|---------------------|---|
| 1. Heat Pump        | 9 Drain pipe                              |
| 2. Wired Controller | 10 Ball valve                             |
| 3. DHW water pump   | 11. Compressor                            |
| 4. DHW temp sensor  | 12. Air Conditioning plate heat exchanger |
| 5. DHW water tank   | 13. Hot Water Plate heat exchanger        |
| 6. Safety valve     | 14 Expansion Tank                         |
| 7. Filter           | 15 Ball valve                             |
| 8. Water pump       | 16/17 Air discharge valve                 |

### Method 2

#### DHW with Room Heating

----- Control signal  
 \_\_\_\_\_ Water circulation

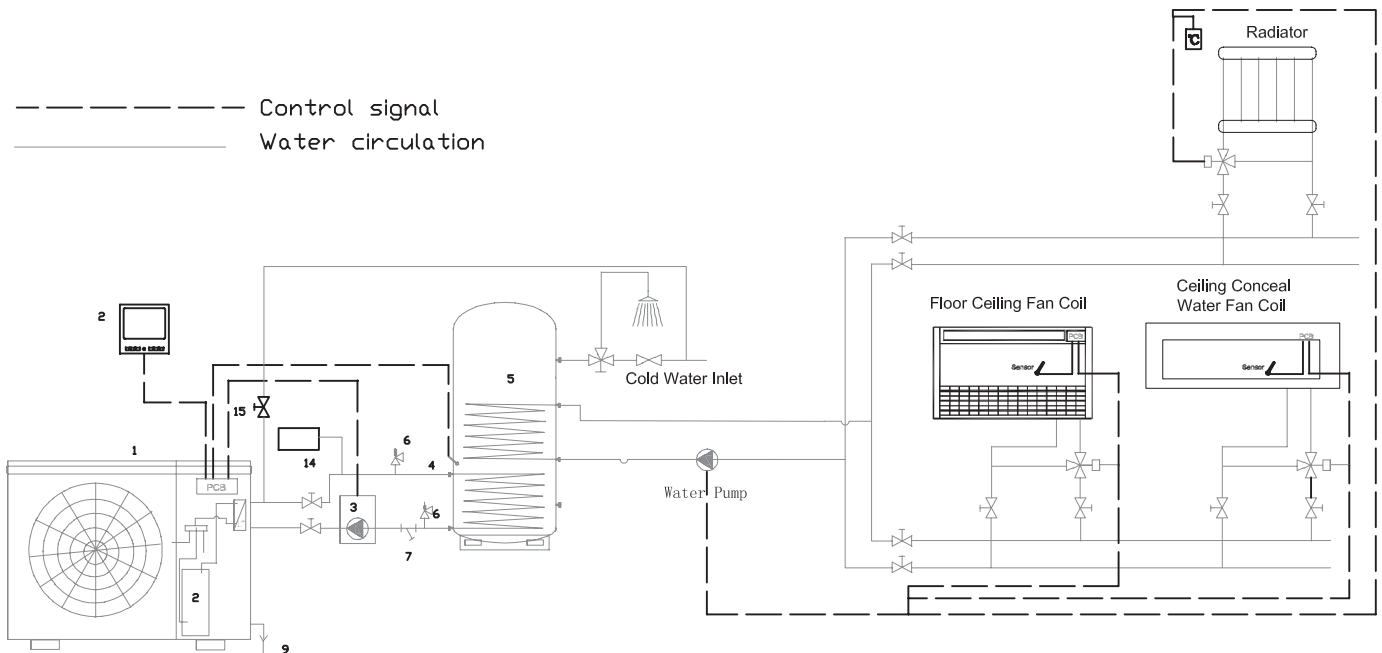

## Method 3

## Air Conditioning Heating and Cooling

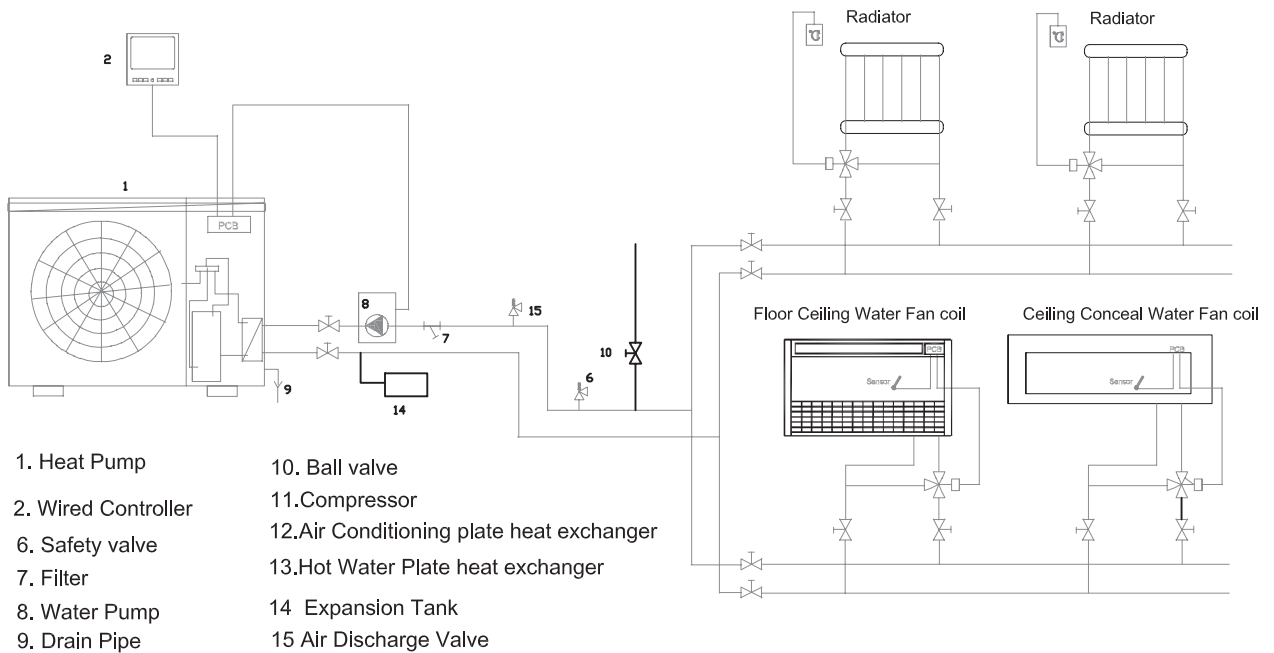

## Method 4

## Heating & Cooling & DHW

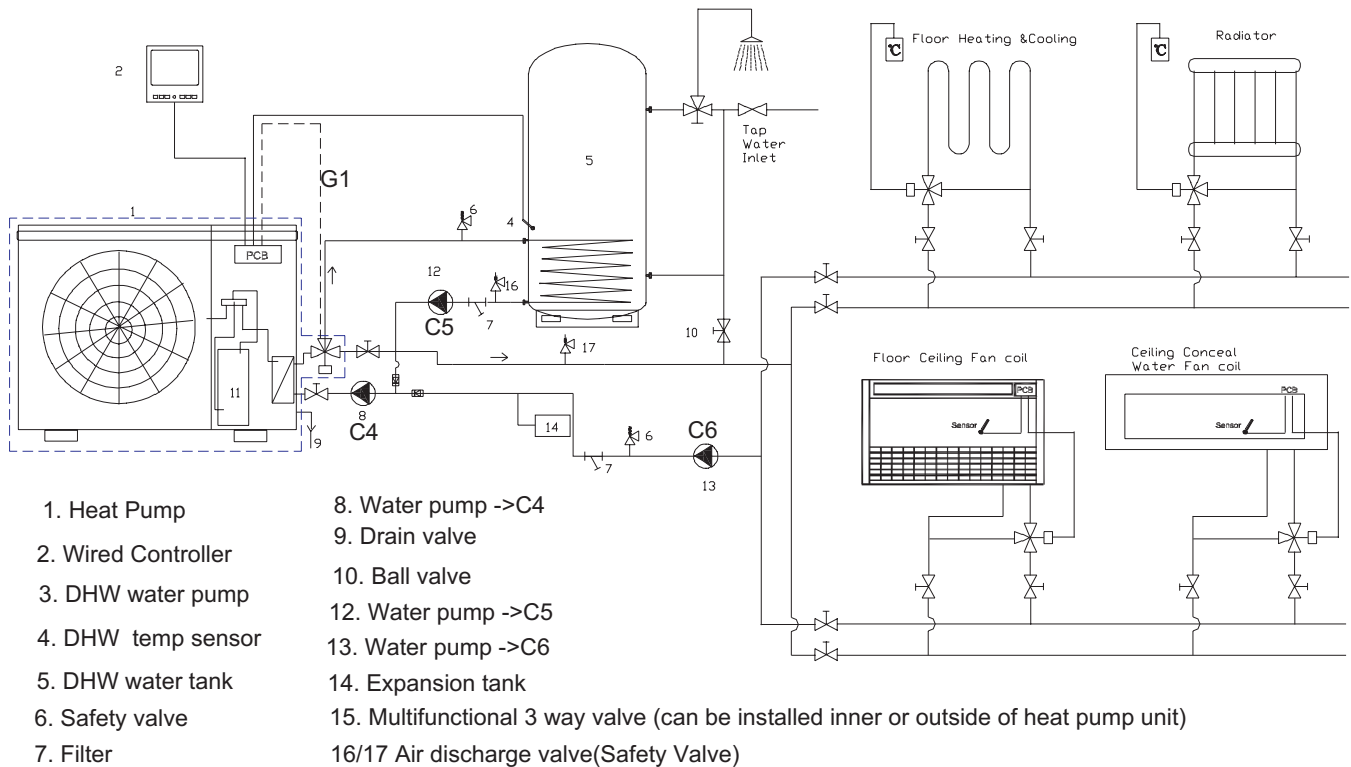

### Note:

1. C4 water pump and multifunctional box can be built inside of heat pump according to order requirement.
2. C4 water pump can be used for both DHW and air conditioning water circulation.
3. installer should check the actual water resistance and make sure to keep enough minimum water flow volume, if necessary, more water pumps should be added for DHW (C5 water pump) and air conditioning (C6 water pump) water circulation. The water pump connection can be found in wiring diagram.
4. Safety valve (air discharge valve) should be installed at the top of the circulation system for easy air discharge. Air conditioning circulation can utilize the fan coil or radiator air discharge valve.

# 5 Installation

## 5.3 Installation with solar assistant

### Application 1 Only DHW with Solar

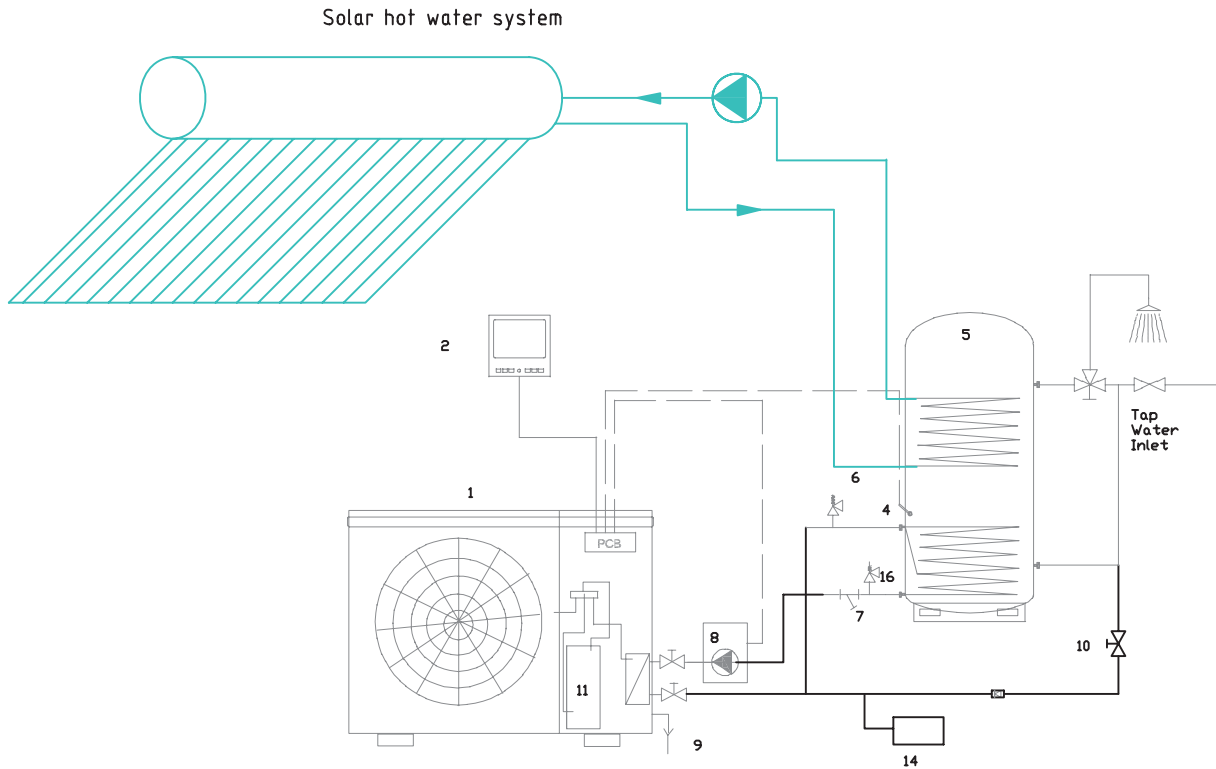

### Application 2 Multifunctional heat pump with solar assistant DHW

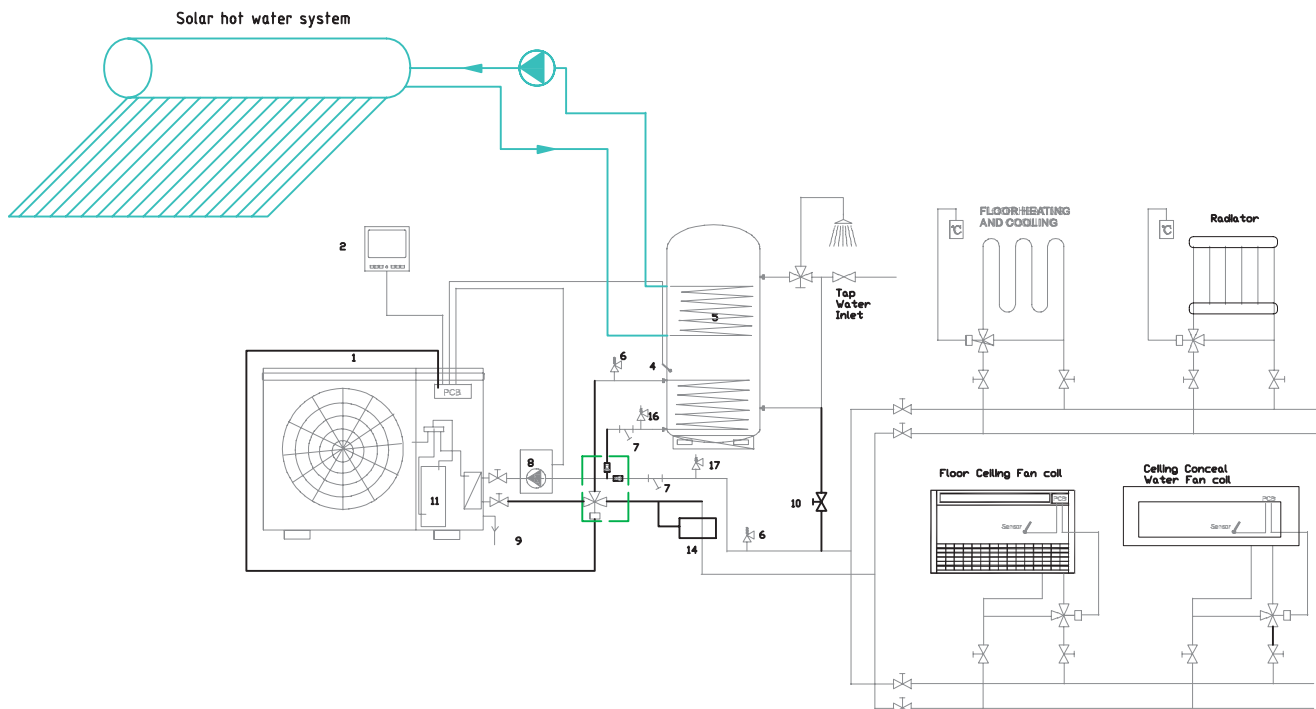

# 5 Installation

## 5.3 Installation with solar assistant

### Application 3 The most energy saving application

Multifunctional heat pump application for solar assist for room heating and DHW

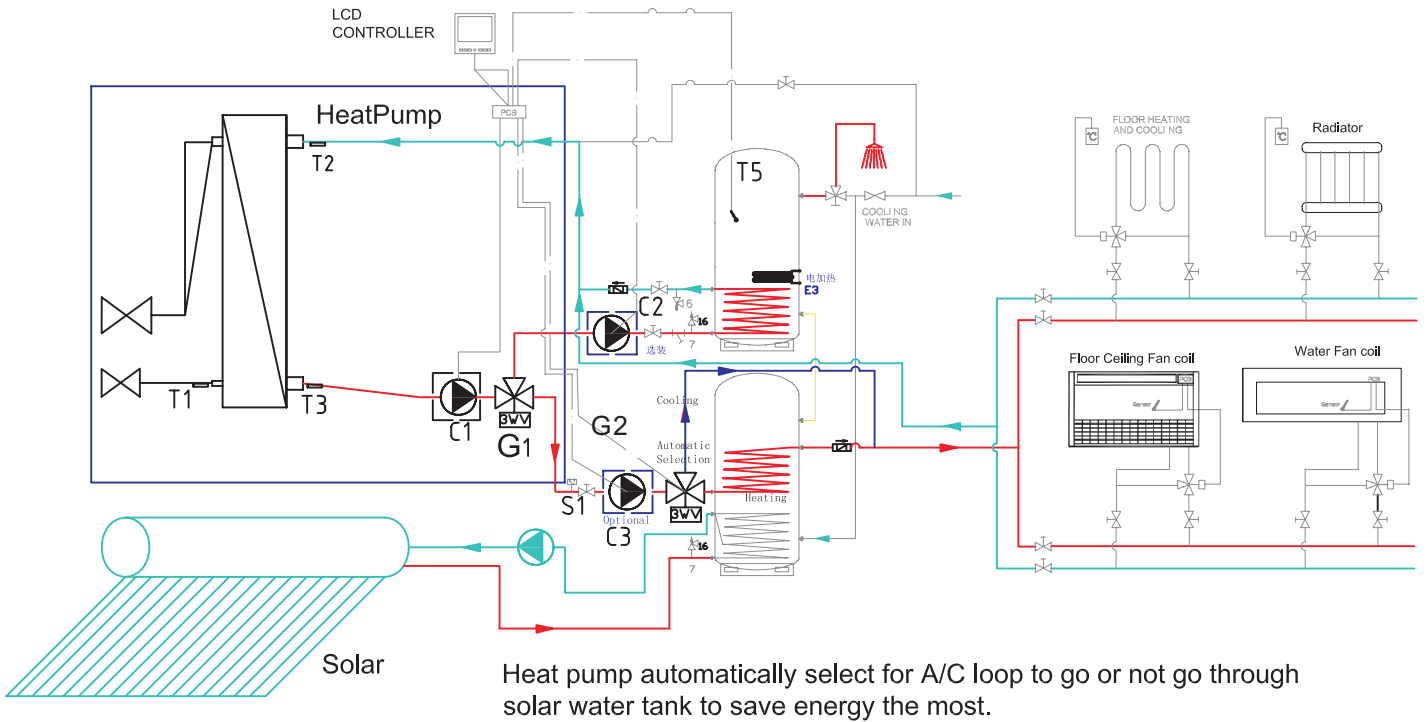

G1: DHW and AC switching valve  
G2: Solar automatic selection valve



## 5 Installation

### 5.3 Dimensions

AH-8/9 AH-14/15

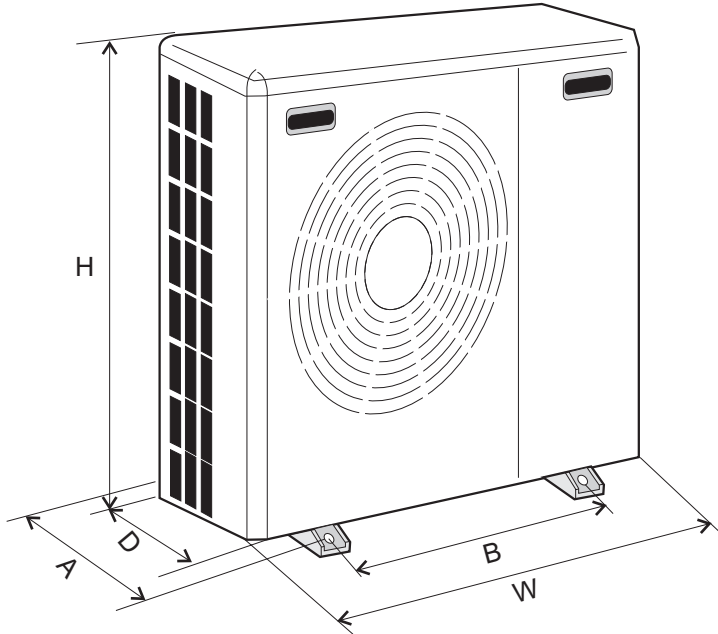

Model	AH-8/9	Model	AH-14/15
W	1090	W	1090
D	400	D	400
H	818	H	1018
A	412	A	412
B	810	B	810

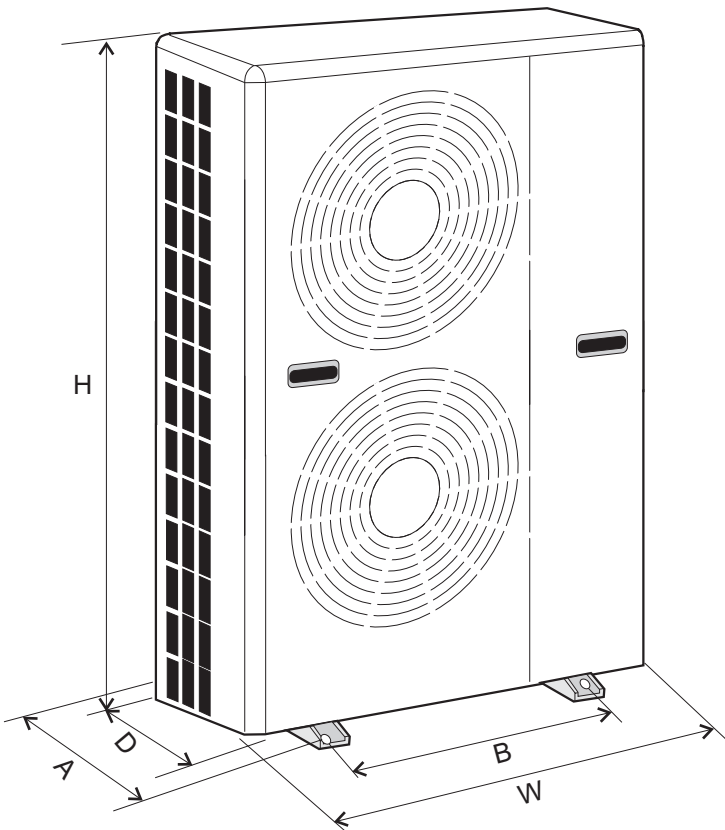

# 5 Installation

## 5.4 Installation position

**Note!**

**Installation must be carried out by professional personnel.**

- 1 If the unit is to be installed on the floor, its undercarriage should be heightened, to avoid ingress of accumulated water in rainy season. In snowy areas, it is important to prevent accumulated snow from blocking up the air-out. The recommended height is 20cm to 30cm.
- 2 Drain ditch or other facilities should be arranged under the outdoor unit, to avoid the environment influence because of water discharge.
- 3 To install the unit at balcony or top of building, the installation site must meet the allowable bearing capacity of building structure, without affecting the structural safety.
- 4 Ensure the unit is well ventilated, direction of air exhaust is kept away from windows of neighboring buildings, and the exhaust air cannot flow back. moreover, adequate service clearance should be kept around the unit.
- 5 The unit should not be installed at places accompanied with oil, inflammable gases, corrosive components e.g. sulfur compound, or high-frequency equipment.
- 6 The unit must be installed upon reliable machine base or framework. Weight capacity of framework should be 3 times of the body weight, and safeguard measures should be taken to avoid malfunction of fastenings.
- 7 The unit should not be installed at sites with typhoon/ earthquake hazards. Midair installation should be avoided as much as possible, for machine falling may result in severe accident.

### Installation in exceptional circumstances(unit:mm)

**No obstacle in front of the unit**

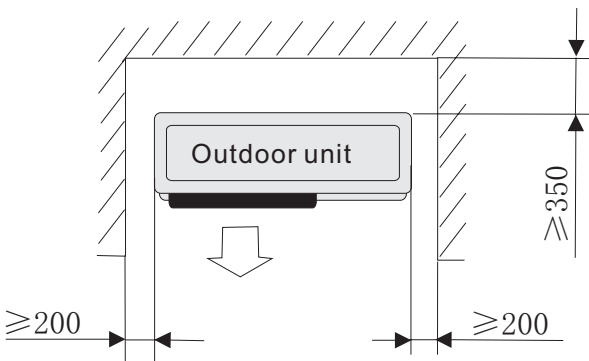

**Obstacle above the unit**

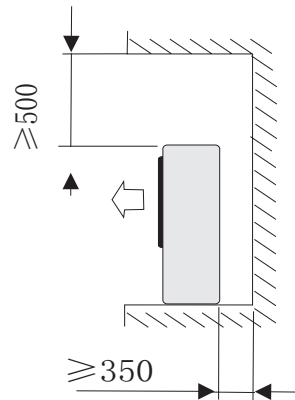

**Obstacle in front of the unit**

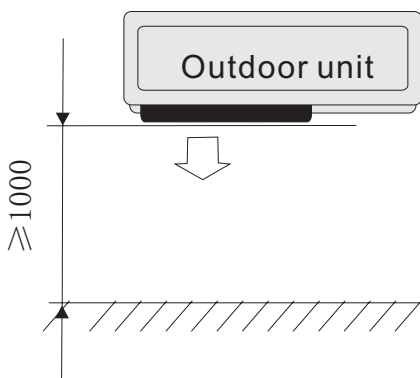

**Several units in a row**

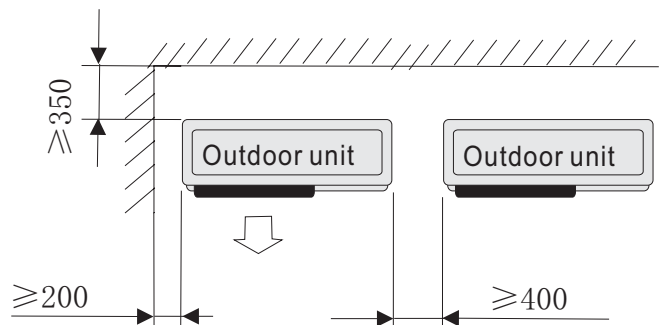

## 6 Electric connection

### 6.1 General

#### Note!

**Electrical installation and service must be carried out under the supervision of a qualified electrician. Electrical installation and wiring must be carried out in accordance with the stipulations in force.**

The heat pump must not be connected without the permission of the electricity supplier and must be connected under the supervision of a qualified electrician.

Wires, spare parts and materials etc. must satisfy the relevant standards issued by the host country or region.

The heat pump does not include an isolator switch on the incoming electrical supply. The power supply cable must be connected to a circuit-breaker with at least a 3 mm breaking gap. Incoming supply must comply with the technical requirements, with ground wire, via a distribution board with fuses.

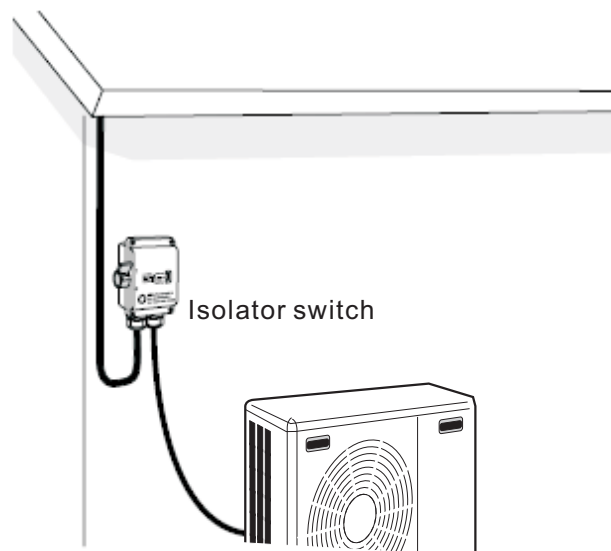

If an insulation test is to be carried out in the building, please make sure to disconnect the heat pump.

To avoid the possibility of false action caused by electromagnetic coupling, the communication wire must be STP (Shielded Twisted Pair). The size of communication wire should not be less than  $0.5\text{mm}^2$ .

Connection method between wired controller and control board:

With nonpolar double wires, maximum 100m length.

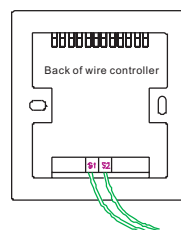

# 6 Electric connection

## 6.3 Wiring Diagram

### Electrical diagram

#### Single Phase

The parts with dotted circle are optional parts according to actual installation requirement.

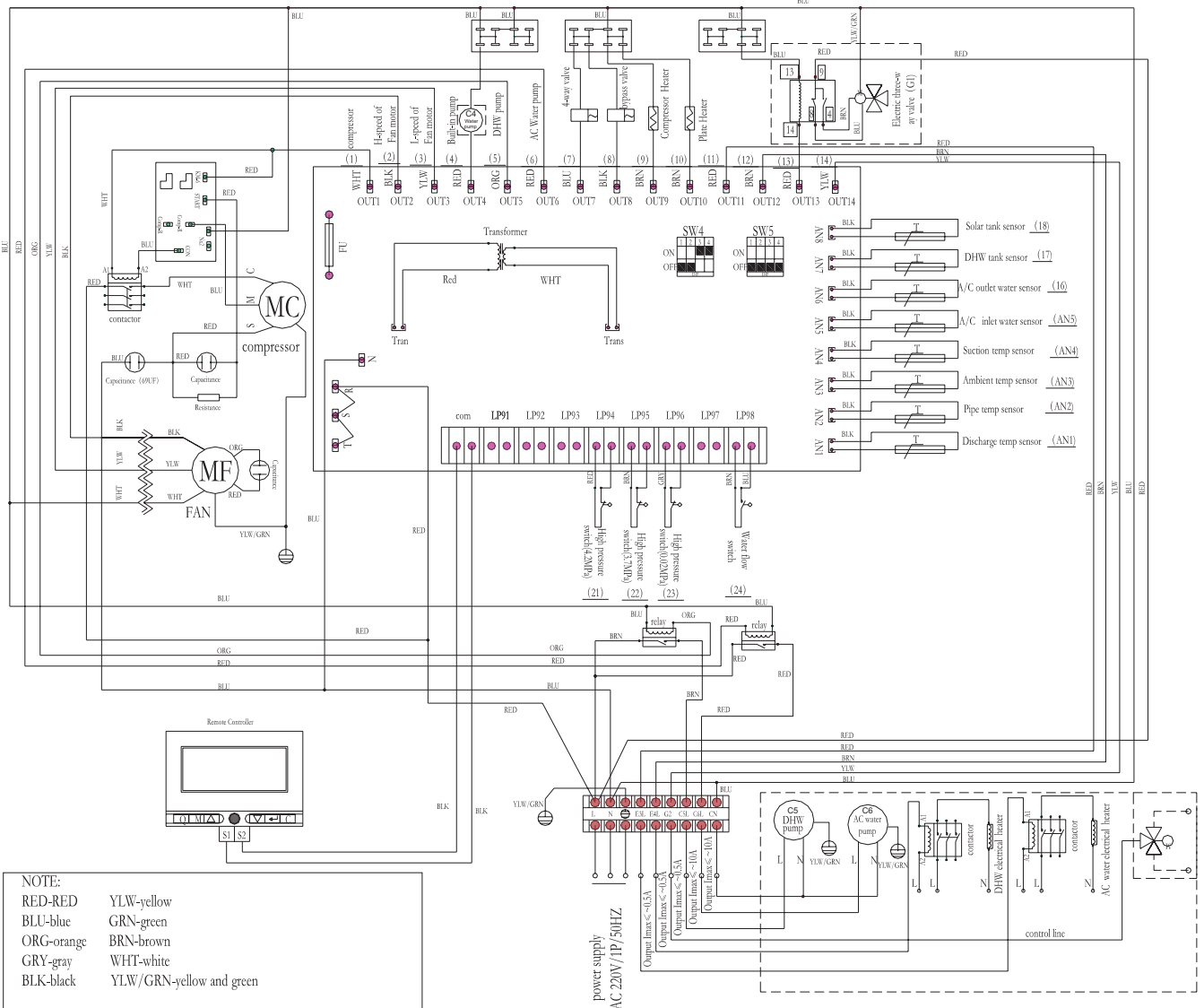

- NOTE:
- RED-RED YLW-yellow
  - BLU-blue GRN-green
  - ORG-orange BRN-brown
  - GRY-gray WHT-white
  - BLK-black YLW/GRN-yellow and green

C4: water pump for both DHW and A/C  
 C5: water pump is additional option for DHW  
 C6: water pump is additional option for A/C



**C4 water pump is not built inside for standard model. There will be C4 connection port at the terminals in that case.**

## 7 Test Run

### 7.1 Preparation

After finish the installation tasks, please check the items:

1 Check the dip switch setting and short wiring as shown below to be sure of correct electricity connection. The DIP switch can only be set at factory or by authorized engineer. Any improper setting may cause unrecoverable damage or malfunction.

SW4-1: Single phase:  Three phase: 

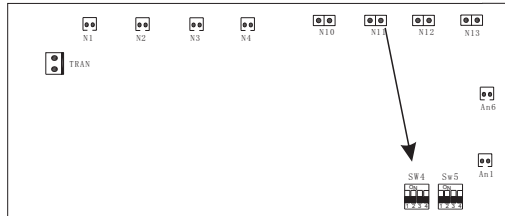

2 cable

Check if the power cable is connected correctly, and check if the screws have been screwed down. *Please use specified communication cables.*

3 Water circuit

Check if the water pipes are correctly connected, and the pipe dimensions are correct.

Heatproof measures must be taken for water outlet pipes and water inlet.

Check if all the shut off valve and manual valve is opened, check if all the joint is fastened.

### 7.2 Water filling

Before fill the water to heat pump water system, please make sure the whole water system is connected correctly, all the piping joints are fasten good.

Two method of water filling

- 1、 For similar installation system as installation method 1, please open the tap water valve, open ball valve 10, air discharge valve 15 and water tank air discharge valve, until the water is full. Then close air discharge valve 15, ball valve 10 and water tank air discharge valve.
- 2、 For similar installation system as installation method 2, please open the tap water valve, open ball valve 10, 15, air discharge 16, air discharge 17 and water tank air discharge valve, until the water is full. Then close air discharge valve 16, 17, ball valve 10, 15 and water tank air discharge valve.

### Running

Turn on the heat pump

select cooling, heating, domestic hot water mode, check whether the unit is running properly or not, the compressor will be started in 3~5 minute after powered on.

**Note: Please only select heating model before assuring the water pump is working properly.**

### Important Notice for Antifreeze to Avoid heat pump broken

Our heat pump has antifreeze function if the electricity is connected. So please keep the electricity always connected even when you don't use the heat pumps. If you don't want to use the heat pumps for long time in winter or if the electricity is cut off by accident for more than 30 minutes, you need to drain out all the recycling water to protect the heat pump to be frozen.

In cold area, for the safety, you'd better use brine as the fluid in the heat pump water system instead of pure water. If the lowest air temperature come to  $-10^{\circ}\text{C}$ , you need add 25% C2H6O2 (Ethylene glycol) to the clean pure water. If the lowest air temperature come to  $-25^{\circ}\text{C}$ , you need to add 40% C2H6O2 to the clean water.

## 9 Temperature sensor data

The temperature sensor data for water outlet sensor, water inlet sensor, coil pipe sensor, ambient sensor, DHW sensor, Etc.

The sensor model is 3470RT

R25=5K  $\Omega$   $\pm$ 1%

A/D	RT(K $\Omega$ )	t2(°C)	H/L
10	105.780	-36.9	0 10
12	87.433	-33.8	0 12
14	74.329	-31.1	0 14
16	64.500	-28.7	1 0
18	56.856	-26.5	1 2
20	50.740	-24.5	1 4
22	45.736	-22.6	1 6
24	41.567	-20.9	1 8
26	38.038	-19.2	1 10
28	35.014	-17.7	1 12
30	32.393	-16.2	1 14
32	30.100	-14.8	2 0
34	28.076	-13.5	2 2
36	26.278	-12.2	2 4
38	24.668	-10.9	2 6
40	23.220	-9.7	2 8
42	21.910	-8.6	2 10
44	20.718	-7.4	2 12
46	19.630	-6.3	2 14
48	18.633	-5.2	3 0
50	17.716	-4.2	3 2
52	16.869	-3.2	3 4
54	16.085	-2.2	3 6
56	15.357	-1.2	3 8
58	14.679	-0.2	3 10
60	14.047	0.7	3 12
62	13.455	1.7	3 14
64	12.900	2.6	4 0
66	12.379	3.5	4 2
68	11.888	4.4	4 4
70	11.426	5.3	4 6
72	10.989	6.1	4 8
74	10.576	7.0	4 10
76	10.184	7.8	4 12
78	9.813	8.7	4 14
80	9.460	9.5	5 0
82	9.124	10.4	5 2
84	8.805	11.2	5 4
86	8.500	12.0	5 6
88	8.209	12.8	5 8
90	7.931	13.6	5 10
92	7.665	14.5	5 12
94	7.411	15.3	5 14
96	7.167	16.1	6 0
98	6.933	16.9	6 2
100	6.708	17.7	6 4
102	6.492	18.5	6 6
104	6.285	19.3	6 8
106	6.085	20.1	6 10
108	5.893	20.9	6 12
110	5.707	21.7	6 14
112	5.529	22.5	7 0
114	5.356	23.2	7 2

A/D	RT(K $\Omega$ )	t2(°C)	H/L
132	4.039	30.6	8 4
134	3.915	31.4	8 6
136	3.794	32.2	8 8
138	3.677	33.1	8 10
140	3.563	33.9	8 12
142	3.452	34.8	8 14
144	3.344	35.7	9 0
146	3.240	36.5	9 2
148	3.138	37.4	9 4
150	3.039	38.3	9 6
152	2.942	39.2	9 8
154	2.848	40.1	9 10
156	2.756	41.1	9 12
158	2.667	42.0	9 14
160	2.580	43.0	10 0
162	2.495	43.9	10 2
164	2.412	44.9	10 4
166	2.331	45.9	10 6
168	2.252	46.9	10 8
170	2.175	47.9	10 10
172	2.100	49.0	10 12
174	2.026	50.1	10 14
176	1.955	51.1	11 0
178	1.884	52.3	11 2
180	1.816	53.4	11 4
182	1.748	54.6	11 6
184	1.683	55.7	11 8
186	1.618	57.0	11 10
188	1.555	58.2	11 12
190	1.494	59.5	11 14
192	1.433	60.8	12 0
194	1.374	62.2	12 2
196	1.316	63.6	12 4
198	1.260	65.0	12 6
200	1.204	66.5	12 8
202	1.150	68.1	12 10
204	1.096	69.7	12 12
206	1.044	71.3	12 14
208	0.992	73.1	13 0
210	0.942	74.9	13 2
212	0.892	76.8	13 4
214	0.844	78.7	13 6
216	0.796	80.8	13 8
218	0.750	83.0	13 10
220	0.704	85.3	13 12
222	0.659	87.8	13 14
224	0.614	90.4	14 0
226	0.571	93.3	14 2
228	0.528	96.3	14 4
230	0.486	99.6	14 6
232	0.445	103.2	14 8
234	0.404	107.1	14 10
236	0.364	111.5	14 12

## 9 Temperature sensor data

The temperature sensor data for compressor exhaust gas temperature sensor.

The sensor model is 3950RT

R 25=10K Ω , B 25/50=3950

A/D	RT(K Ω )	t2(°C)	H	L
10	246.000	-33.0	0	10
12	203.333	-30.2	0	12
14	172.857	-27.7	0	14
16	150.000	-25.6	1	0
18	132.222	-23.6	1	2
20	118.000	-21.8	1	4
22	106.364	-20.1	1	6
24	96.667	-18.6	1	8
26	88.462	-17.1	1	10
28	81.429	-15.7	1	12
30	75.333	-14.4	1	14
32	70.000	-13.1	2	0
34	65.294	-12.0	2	2
36	61.111	-10.8	2	4
38	57.368	-9.7	2	6
40	54.000	-8.6	2	8
42	50.952	-7.6	2	10
44	48.182	-6.6	2	12
46	45.652	-5.6	2	14
48	43.333	-4.7	3	0
50	41.200	-3.8	3	2
52	39.231	-2.9	3	4
54	37.407	-2.0	3	6
56	35.714	-1.1	3	8
58	34.138	-0.3	3	10
60	32.667	0.6	3	12
62	31.290	1.4	3	14
64	30.000	2.2	4	0
66	28.788	3.0	4	2
68	27.647	3.8	4	4
70	26.571	4.5	4	6
72	25.556	5.3	4	8
74	24.595	6.1	4	10
76	23.684	6.8	4	12
78	22.821	7.5	4	14
80	22.000	8.3	5	0
82	21.220	9.0	5	2
84	20.476	9.7	5	4
86	19.767	10.4	5	6
88	19.091	11.1	5	8
90	18.444	11.8	5	10
92	17.826	12.5	5	12
94	17.234	13.2	5	14
96	16.667	13.9	6	0
98	16.122	14.6	6	2
100	15.600	15.3	6	4
102	15.098	16.0	6	6
104	14.615	16.7	6	8
106	14.151	17.4	6	10
108	13.704	18.1	6	12
110	13.273	18.8	6	14
112	12.857	19.5	7	0
114	12.456	20.1	7	2
116	12.069	20.8	7	4
118	11.695	21.5	7	6
120	11.333	22.2	7	8
122	10.984	22.9	7	10
124	10.645	23.6	7	12
126	10.317	24.3	7	14
128	10.000	25.0	8	0
130	9.692	25.7	8	2

A/D	RT(K Ω )	t2(°C)	H	L
132	9.394	26.4	8	4
134	9.104	27.1	8	6
136	8.824	27.8	8	8
138	8.551	28.6	8	10
140	8.286	29.3	8	12
142	8.028	30.0	8	14
144	7.778	30.8	9	0
146	7.534	31.5	9	2
148	7.297	32.3	9	4
150	7.067	33.0	9	6
152	6.842	33.8	9	8
154	6.623	34.6	9	10
156	6.410	35.3	9	12
158	6.203	36.1	9	14
160	6.000	36.9	10	0
162	5.802	37.8	10	2
164	5.610	38.6	10	4
166	5.422	39.4	10	6
168	5.238	40.3	10	8
170	5.059	41.2	10	10
172	4.884	42.0	10	12
174	4.713	42.9	10	14
176	4.545	43.8	11	0
178	4.382	44.8	11	2
180	4.222	45.7	11	4
182	4.066	46.7	11	6
184	3.913	47.7	11	8
186	3.763	48.7	11	10
188	3.617	49.8	11	12
190	3.474	50.8	11	14
192	3.333	51.9	12	0
194	3.196	53.1	12	2
196	3.061	54.2	12	4
198	2.929	55.4	12	6
200	2.800	56.7	12	8
202	2.673	57.9	12	10
204	2.549	59.3	12	12
206	2.427	60.6	12	14
208	2.308	62.1	13	0
210	2.190	63.6	13	2
212	2.075	65.1	13	4
214	1.963	66.7	13	6
216	1.852	68.4	13	8
218	1.743	70.2	13	10
220	1.636	72.1	13	12
222	1.532	74.1	13	14
224	1.429	76.3	14	0
226	1.327	78.6	14	2
228	1.228	81.0	14	4
230	1.130	83.7	14	6
232	1.034	86.5	14	8
234	0.940	89.7	14	10
236	0.847	93.2	14	12
238	0.756	97.1	14	14
240	0.667	101.5	15	0
242	0.579	106.6	15	2
244	0.492	112.6	15	4
246	0.407	119.9	15	6
248	0.323	129.2	15	8
250	0.240	141.7	15	10

# 10 Heat Pump Test Run

## Check list before turn on heat pump

Better to print this page out and make sure that you can tick all of the following items to avoid any Problem. After finish the installation tasks, please check the item listed below before turn on heat pump.

Things you should have done:

### 1. Power cable

Check if the power cable is connected correctly, and check if the screws have been screwed down and tight. Please use specified cables.

Yes

### 2. Communication wire

Check if the communication wire is connected correctly, and check if the screws have been screwed down and tight. Please adopt specified communication wire.

Yes

### 3. Water circuit

-a. Check if the water pipes are corrected, and the pipe dimensions are correct.

Yes

-b. Check if all the shut off valve and manual valve is opened, check if all the joint is fastened.

Yes

-C. Check if air exhaust valves on the water terminals must be open for the 1st water recycle running to exhaust air in the terminals . This valve can be closed when this valve drain continuous water.

Yes

-D. Check if air exhaust valves for the whole water circuit is opened. An automatic purging device has to be installed at the highest point of the water circuit.

Yes

-E. Open the maintenance screw in the middle of the water pump (for both DHW and air conditioning circuit) and manually rotate the water pump axis. This action should also be done when electric power disconnected for more than 24 hours to avoid block.

Yes

4. Be sure the two water tanks are full of water. If the water tanks are empty, the electric heaters inside is dangerous to be broken.

Yes

5. Insulation test of power supply circuit . Please inspect it by a ohmmeter of 500V . Apply the voltage of DC 500V between the power supply terminal block and the ground wire, test the insulation resistance. The insulation resistance must be more than 2 ohms.

Yes

## Heat Pump Test Run Prochure

Switch on the power supply

Yes

1. The power indicator (LED) will be lighted. The compressor heater will be started.

Yes

2. Turn on the heat pump and check if the heat pump is in air conditioning mode , if not, please press M button on the LED controller to change the operation mode to heating mode.

Yes

3. The circulation pump will start before the compressor. Make sure the water pump is working well.

Yes

4. The compressor will be started in 3 minute after powered on.

Yes

## MOST IMPORTANT!

1. Make sure it is not in cooling mode during first operation or test running, until you make sure the air conditioning water pump is working properly and water circuit is recycling smoothly.

2. Select a big enough water pump for the air conditioning water circuit.

3. Always keep the electricity connection with heat pump to enable the antifreeze function.



